

# CI Series Multi-function Counter / Timer User Manual



## Features:

1. Counting speed is up to 10KCPS;
2. Prescale coefficient 0.001--99.999 can be freely setting;
3. Universal input, NPN or PNP input can be selected by software;
4. With timing function, up to 9 timing mode;
5. Up to two counting / length counting alarm output, one batch counting alarm output;
6. Applicable to light industries, machinery, packing, food industries, etc. for quantity and length counting and control output, etc.

For your safety, please read following content carefully before you are using our Meter!

## ■ Safe Caution

※ Please read the manual carefully before you use the temperature controller.

※ Please comply with the below important points.

⚠ Warning An accident may happen if the operation does not comply with the instruction.

⚠ Notice An operation that does not comply with the instruction may lead to product damage.

※ The instruction of the symbol in the manual is as below.

⚠ An accident danger may happen in a special condition.

## ⚠ Warning

1. A safety protection equipment must be installed or please contact with us for the relative information if the product is used under the circumstance such as nuclear control, medical treatment equipment, automobile, train, airplane, aviation and equipment etc. Otherwise, it may cause serious loss, fire or person injury.
2. A panel must be installed, otherwise it may cause creepage (leakage).
3. Do not touch wire connectors when the power is on, otherwise you may get an electric shock.
4. Do not dismantle or modify the product. If you have to do so, please contact with us first. Otherwise it may cause electric shock and fire.
5. Please check the connection number while you connect the power supply wire or input signal, otherwise it may cause fire.

## ⚠ Caution

1. This product cannot be used outdoors. Otherwise the working life of the product will become shorter, or an electric shock accident may happen.
2. When you connect wire to the power input connectors or signal input connectors, the moment of the No.20 AWG (0.50 mm<sup>2</sup>) screw tweaked to the connector is 0.74n.m - 0.9n.m. Otherwise the connectors may be damaged or get fire.
3. Please comply with the rated specification. Otherwise it may cause electric shock or fire, and damage the product.
4. Do not use water or oil base cleaner to clean the product. Otherwise it may cause electric shock or fire and damage the product.
5. This product should be avoid working under the circumstance that is flammable, explosive, moist, under sunshine, heat radiation and vibration. Otherwise it may cause explosion.
6. In this unit it must not have dust or deposit, otherwise it may cause fire or mechanical malfunction.
7. Do not use gasoline, chemical solvent to clean the cover of the product because such solvent can damage it. Please use some soft cloth with water or alcohol to clean the plastic cover.

## 1. Model Illustration

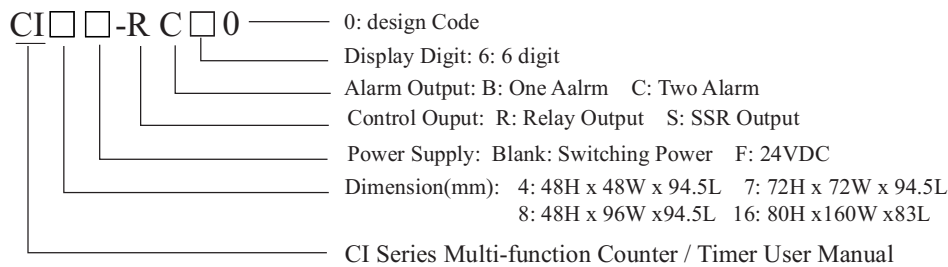

24VDC Power Supply can be ordered

## 2. Model Type

No.	Model	Size (mm)	Output	Display Digit	Alarm Output	Batching Output	Communication
1	CI16-RC60	80H×160W	Relay Output	6	2	One Relay	NO
2	CI16-RC68	80H×160W	Relay Output	6	2	One Relay	RS485
3	CI8-RC60	48H×96W	Relay Output	6	2	One Relay	NO
4	CI8-RC68	48H×96W	Relay Output	6	2	One Relay	RS485
5	CI7-RC60	72H×72W	Relay Output	6	2	One Relay	NO
6	CI7-RC68	72H×72W	Relay Output	6	2	One Relay	RS485
7	CI4-RC60	48H×48W	Relay Output	6	2	NO	NO
8	CI4-RC68	48H×48W	Relay Output	6	2	NO	RS485

## 3. Technical Specification

Series		CI	
Display		Dual Line 6 digit	
Power Supply		100~240V AC/DC	
Fluctuation range of Allowed Voltage		90~110% of Rated Voltage (AC Power)	
Input Frequency of INA, INB		1Hz、30Hz、1KHz、5KHz、10KHz can be choosed	
Width of Input Pulse		INA,INHIBIT,RESET,BATCH RESET,can choose 1ms or 20ms	
Input		Voltage Input: input impedance 5.4KΩ,“H”: 5~30VDC “L”:0~2VDC No-voltage Input: for Short-circuit impedance is 1KΩ, Residual Voltage: Max 2v dc, Open-circuit impedance Max 100KΩ	
One-shot Output	Counter	10/50/100/200/500/1000/2000/5000ms	
	Timer	10/50/100/200/500/1000/2000/5000ms	
Control Output	Contact Capacity	NO:250VAC 3A Impedance NC: 250VAC 2A Impedance	
	SSR Capacity	Max: 30VDC , Max: 100mA	
Data Saving Time		Ten Years	
Power of External Sensor		12VDC±10% Less than 100mA	
Ambient Temperature		-10℃~50℃ Unfreezing State	
Storage Temperature		-25℃~65℃ Unfreezing State	
Ambient Humidity		35-85%RH	
Time Accuracy		Active time function Voltage false Setting False Temperature False	Power On : ±0.05%±0.05sec With Signal : ±0.05%±0.03sec
Dielectric Strength		Min: 100MΩ (at500VDC)	
Dielectric		2000V AC 50/60Hz one minute	
Interference (AC Power)		±2kV Square-wave generator interference (width of pulse: 1us)	
Vibrate	Mechanical	Amplitude:0.75mm Frequency: 10-55Hz X,Y,Z each direction for one hour	
	Fault	Amplitude:0.5mm Frequency: 10-55Hz X,Y,Z each direction for ten minutes	
Impact	Mechanical	(about 30G) X,Y,Z each direction for three times	
	Fault	(about 10G) X,Y,Z each direction for three times	
Using Life	Mechanical	more than 10,000,000 times	
	Electrical	more than 100,000 times (NO: 250V AC 3A Load NC: 250V AC 2A Load)	

## 4. Panel Indication

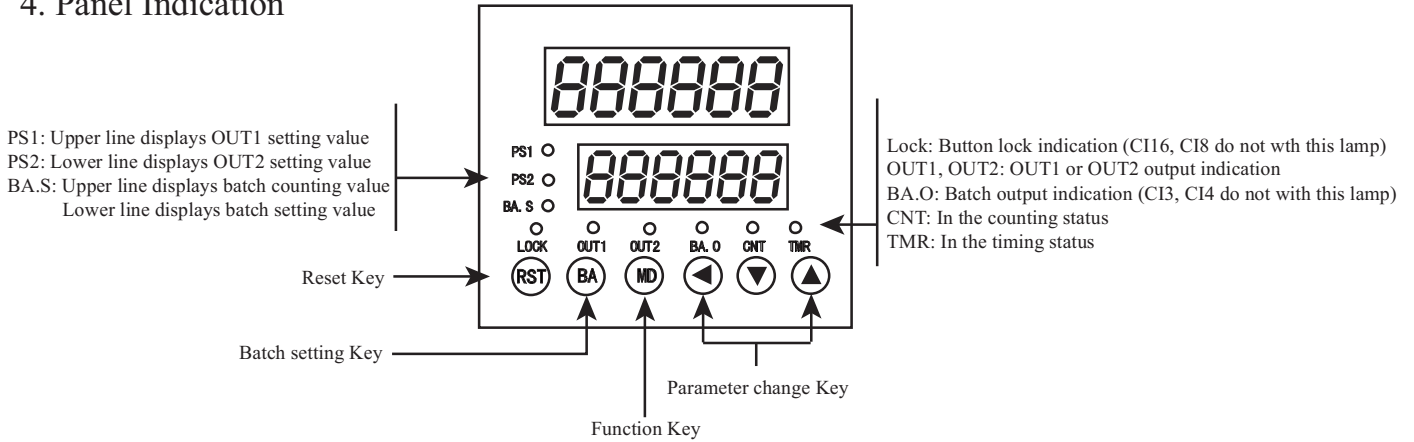

## 5. Operation Instruction

### 1. How to change counter setting value (Example: change the setting value from 175 to 180)

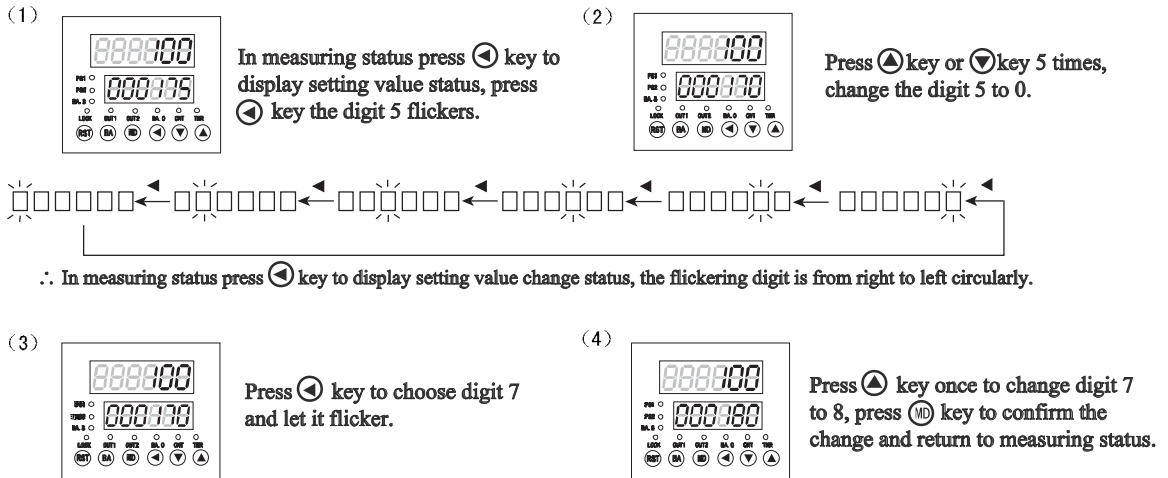

### 2. How to change timer setting value (Output mode is FLK)

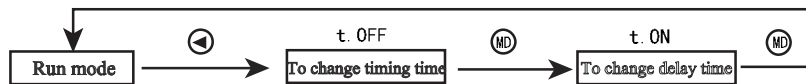

$\therefore$  In setting status, the menu will return to timing status automatically if no operation within 60 seconds.

How to change t.OFF time to 50sec from 30sec, change t.ON time to 20sec from 40sec (output mode: FLK timing range: 0.1s to 99999.9s).

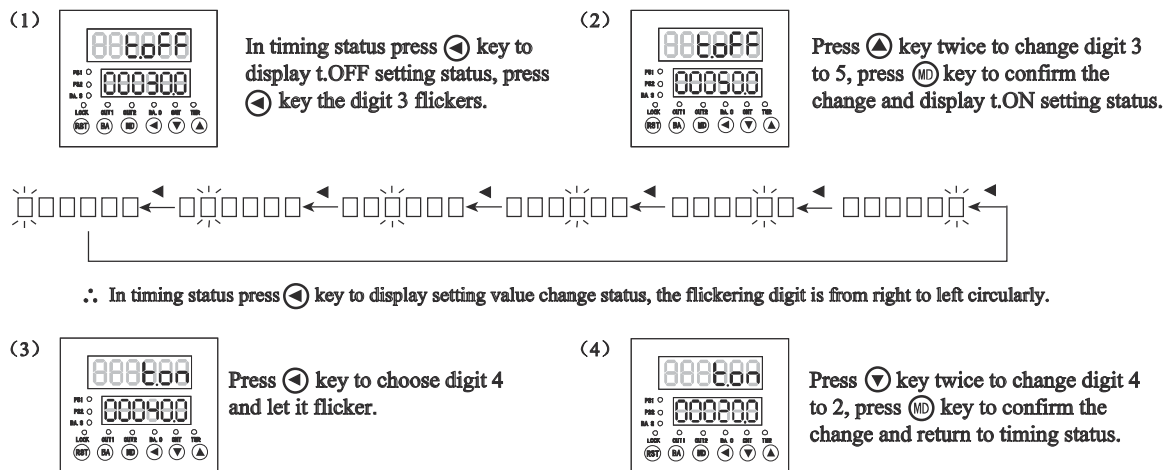

## 6. Batch Counting and Batch Preset

### 1. Batch Counting Action

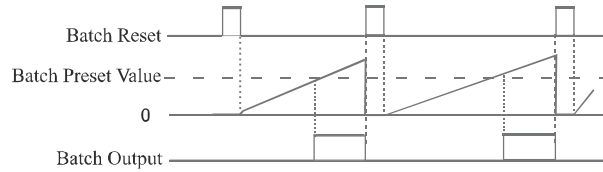

#### ◆ Batch counting

Batch counting value counts up, it will not be reset unless external BATCH reset signal is applied.  
 When batch counting value counts over 999999, it will be reset to 0 and counts again.  
 Batch counting value is not reset by front **[RST]** key or external reset signal.

#### (1) Batch counting in Counting mode.

Batch alarm outputs when counting alarm output quantity is equal to the batch setting value.  
 When batch control output is used, the time interval of counting up process is bigger than 10mS.

#### (2) Batch counting in Timing mode.

Batch alarm outputs when timing alarm output quantity is equal to the batch setting value.  
 In FLK output mode, the counting value of Batch counter is counting up, when Toff and Ton setting time passes.

#### ◆ Batch output action

If batch output is ON, it will keep ON status until batch reset signal is applied.  
 If batch output is ON, after power off and then power on again, batch output keeps ON status until external reset signal is applied.

### 2. How to change batch setting value

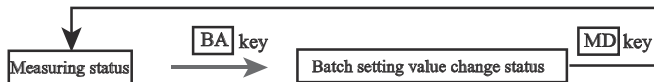

- ◆ In measuring status press **BA** key to display batch setting value change status. The method for changing batch setting value is the same as the one for changing counting setting value. Press **[▲]** key to select the digit to be changed to let it flicker, and then press **[▼]** key to change the value. Press **[MD]** key to confirm and menu returns to measuring status.  
 After changing the value, the upper LED will display the current batch counting value.
- ◆ When batch setting value is bigger than batch counting value, if the setting value is changed (equal or smaller than the counting value, the batch output takes action.
- ◆ If batch setting value is 0, the batch output is in OFF state.
- ◆ When menu is batch setting value change status, if no button operation within 60 second, the menu will return to measuring status.

## 7. Application of Prescale Function

E.g.: Pulse number P is a number of pulse created by rotary encoder, L is the measured length,,  
 Prescale value is equal to L divides P.

④ To use counter and rotary encoder to control length

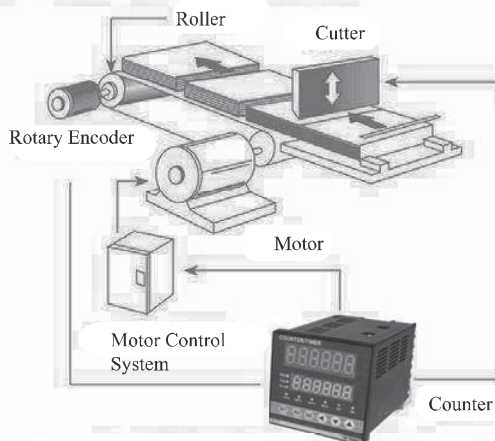

$$\begin{aligned} \text{Prescale Value} &= \frac{\pi \times \text{Diameter of the roller (D)}}{\text{Pulse numbers per 1 revolution of the encoder}} \\ &= \frac{3.1416 \times 22}{1000} \\ &= 0.069 \text{mm/pulse} \end{aligned}$$

Set 0.069 of prescale value at prescale value set mode.

The diameter of the roller connected to the rotary encoder is 22mm.  
 The pulse number per 1 revolution of the encoder is 1000.





## 12. Input Operation Mode For Counter

\*Ⓐ: Over Min. signal width, Ⓑ: Over 1/2 of Min. signal width.

Input Type	Illustration	Note
U (Add)		INA: Counting Input INB: Control Input INB=L; INA pulse input add count INB=H; INA forbod to count
		INA: Control Input INB: Counting Input INA=H; INB pulse input add count INA=L; INB forbod to count
D (Minus)		INA: Counting Input INB: Control Input INB=L; INA pulse input minus count INB=H; INA forbod to count
		INA: Control Input INB: Counting Input INA=H; INB pulse input minus count INA=L; INB forbod to count
Ud-a (Add/ Minus-A) Order Input		INA: Counting Input INB: Control Input INB=L; INA pulse input add count INB=H; INA input pulse minus count
Ud-b (Add/Minus-B) Sole Input		INA input pulse, add count INB input pulse, minus count
Ud-c Phase Difference Input		INA before, INB add count INA delay, INB minus count Phase difference input (for rotary encoder)

When using rotary encoder's A, B ohase output, please connect meter's INA, INB input terminal, and turn the input mode to Ud-C.

Symbol \ Input Type	Voltage Input (PNP)	Terminal Input (NPN)
H	5-30VDC	Short Circuit
L	0-2VDC	Open Circuit

### 13. Output Operation Mode For Counter

		Input Mode			Operation after reached the setting
		Up	Down	Up/Down A, B, C	
F	Reset 999999 Display SV2 SV1 0 OUT1 Output OUT2 Output				Display will continue to increase or decrease, output will be kept to the reset input
N	Reset 999999 Display SV2 SV1 0 OUT1 Output OUT2 Output				Display and output will be kept to the reset input
C	Reset 999999 Display SV2 SV1 0 OUT1 Output OUT2 Output				Display value will return to the start status automatically, output delay will return to the initial status after reached the setting time. (Output activity is repeat single output)
R	Reset 999999 Display SV2 SV1 0 OUT1 Output OUT2 Output				Display value and output will automatically return to the initial status after keep to the delay setting time. (Output activity is repeat single output)
K	Reset 999999 Display SV2 SV1 0 OUT1 Output OUT2 Output				Display value will continue to increase or decrease until reset input, output delay will return to the initial status after reached the setting time. (Output activity is repeat single output)
P	Reset 999999 Display SV2 SV1 0 OUT1 Output OUT2 Output				Display value kept to the delay time, will display the next cycle. (In the delay time, the next cycle counting and timing from initial status) (Output activity is repeat single output)
Q	Reset 999999 Display SV2 SV1 0 OUT1 Output OUT2 Output				Display value will continue to increase or decrease within output delay time, display value and output will return to the initial status after output delay reached the setting time. (Output activity is repeat single output)
A	Reset 999999 Display SV2 SV1 0 OUT1 Output OUT2 Output				Display value and OUT1 output will be kept to the reset input, OUT2 output will return to the initial status after reaching the setting time. (Output activity is repeat single output)

	Up/DownA, B, C	Operation
S		OUT1 and OUT2 meet following conditions, will keep ON status: Display Value $\geq$ Setting Value 1 Display Value $\geq$ Setting Value 2
T		OUT1 keeps OFF status when display value is smaller than the preset 1 value, but if preset value is "0", OUT1 keeps ON status. When display value is smaller than the preset value "2", OUT2 keeps ON status
D		When display value = setting value OUT1 and OUT2 keeps ON status When the speed of counter meter setting to 1kcp, should use SSR output

## 14. Operation Mode Change

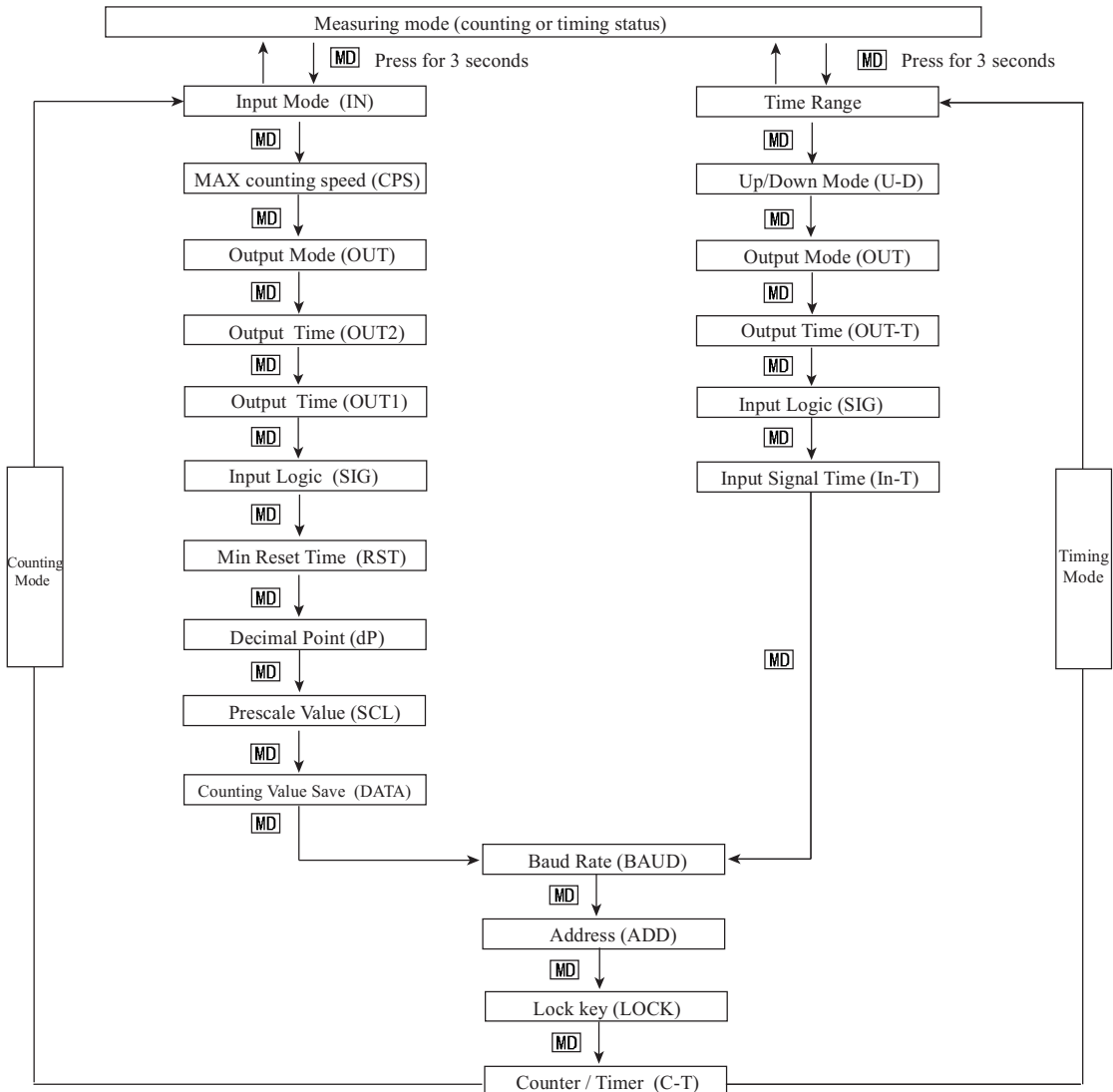

- ※ Under the mode of Counting can directly change to Timing mode;
- ※ In the mode of function setting, counter will return to the measuring status automatically after without any operation for 60 seconds.

# Timer Output Operation Mode

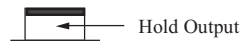
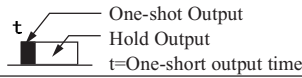

Output Mode	Time and Sequence	Activation
<i>ond</i> (OND)	SIGNAL ON DELAY (POWER OFF RESET)	<ol style="list-style-type: none"> <li>1. Timer starts when INA signal turns ON; when INA signal turns OFF, time reset.</li> <li>2. Timer starts when power turns ON and when reset turns OFF during INA signal ON.</li> <li>3. Control output operate decide by hold or One-short time.</li> </ol>
<i>ond.1</i> (OND. 1)	SIGNAL ON DELAY 1 (POWER OFF RESET)	<ol style="list-style-type: none"> <li>1. Timer starts when INA signal turns ON; when INA signal turns OFF, timing keeps on.</li> <li>2. counting starts when power turns ON , Reset signal OFF and INAsignal ON</li> <li>3. Control output operate decide by hold or One-short time.</li> </ol>
<i>ond.2</i> (OND. 2)	POWER ON DELAY (POWER OFF COUNTING KEEP)	<ol style="list-style-type: none"> <li>1. Timing starts when power on and the data will be kepted when power off.</li> <li>2. counting starts when reset signal OFF ,Pause signal OFF and power ON</li> <li>3. Control output operate decide by hold or One-short time.</li> </ol>
<i>FLK</i> (FLK)	FLCKER (Power OFF Reset)	<ol style="list-style-type: none"> <li>1. Timing starts when INA signal turns on, if INA signal is applied repeatedly, only initial signal is recognized.</li> <li>2. When power ON , reset signal is OFF and INA signal ON, it starts to timing.</li> <li>3. Control output operation is decided by hold output, when the time comes to Toff setting time or Ton setting time, output is ON or OFF. (No One-shot output)</li> <li>4. Each Ton time and Toff time should be setted separtately.</li> <li>5. When using terminal output, the setting time must over than 100ms.</li> </ol>
<i>FLK.1</i> (FLK. 1)	FLCKER1 (Power OFF Reset): Hold output	<ol style="list-style-type: none"> <li>1. Timing starts when INA signal turns on, if INA signal is accepted, only initial signal is recognized.</li> <li>2. When power ON , reset signal is OFF and INA signal ON, it starts to timing.</li> <li>3. Control output operate decide by hold output, when using terminal output, the setting time must over than 100ms.</li> </ol>
<i>FLK.1</i> (FLK. 1)	FLCKER1 (Power OFF Reset): One-shot output	<ol style="list-style-type: none"> <li>1. Timing starts when INA signal turns on, if INA signal is accepted, only initial signal is recognized.</li> <li>2. When power ON , reset signal is OFF and INA signal ON, it starts to timing.</li> <li>3. Control output operate decide by one-shot output, when using terminal output, the setting time must over than 100ms.</li> </ol>

F1L2 (FLK)	<p>FLCKER2 (POWER OFF HOLD): HOLD OUTPUT</p>	<ol style="list-style-type: none"> <li>1. Timing starts when INA signal turns on, if INA signal is accepted, only initial signal is recognized.</li> <li>2. Control output operate is decided by Hold output which will be kept to the next setting value.</li> <li>3. When power ON , reset signal is OFF and INA signal ON, it starts to timing.</li> <li>3. when using terminal output, the setting time must over than 100ms</li> </ol>
	<p>FLCKER2 (POWER OFF HOLD): One-shot OUTPUT</p>	<ol style="list-style-type: none"> <li>1. Timing starts when INA signal turns on, if INA signal is accepted, only initial signal is recognized.</li> <li>2. Control output operate is decided by One-shot output which will be kept to the setting value.</li> <li>3. When power ON , reset signal is OFF and INA signal ON, it starts to timing.</li> <li>3. when using terminal output, the setting time must over than 100ms</li> </ol>
17L (INT)	<p>INTERVAL (POWER/SIGNAL RESET)</p>	<ol style="list-style-type: none"> <li>1. Timing starts when INA signal turns to ON.</li> <li>2. Timing reset when INA signal turns to OFF.</li> <li>3. When power ON, reset signal OFF and INA signal ON, it starts to timing.</li> <li>4. Display value and Control output will reset automatically after reach the setting time.</li> <li>5. In the process of timing, control output is ON</li> </ol>
	<p>INTERVAL (POWER OFF RESET)</p>	<ol style="list-style-type: none"> <li>1. When INA signal turns to ON, control output will turns to ON and starts to counting.</li> <li>2. If INA signal is repeatedly showed, only initial signal is recognized.</li> <li>3. When power ON, reset signal OFF and INA signal ON, it starts to timing.</li> <li>4. Display value and Control output will reset automatically after reach the setting time.</li> <li>5. In the process of timing, the INA signal keeps ON</li> </ol>
0F0 (OFD)	<p>INTERVAL 1 (POWER OFF RESET)</p>	<ol style="list-style-type: none"> <li>1. When power ON and reset signal OFF, in the time of INA signal ON, control output will keep ON status.</li> <li>2. Display value and Control output will reset automatically after timing reach the setting time.</li> </ol>

## 15.Connection Drawing

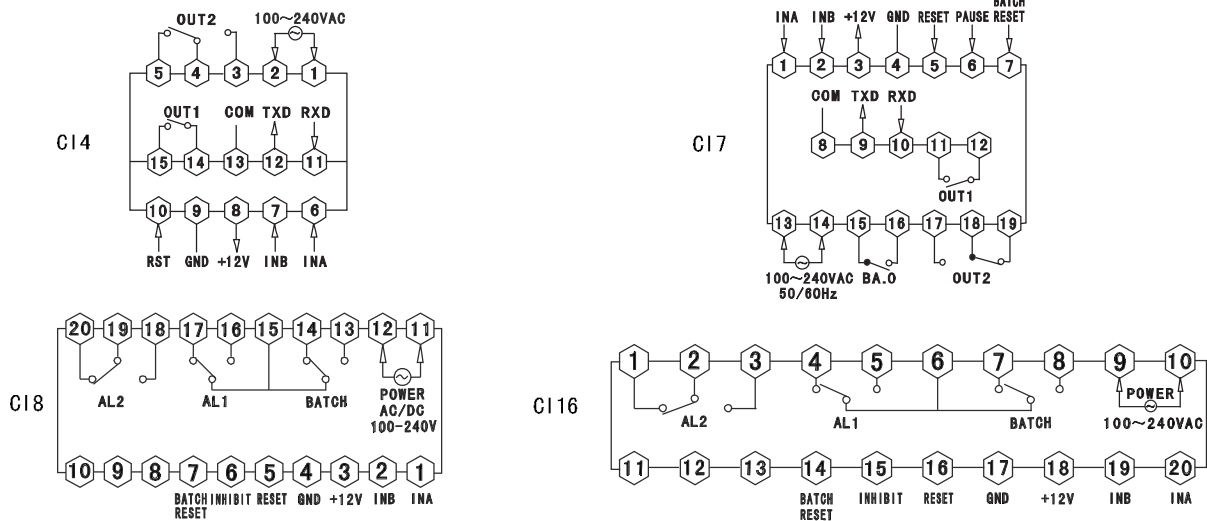

Note: If there is any change, please subject to the drawing on the meter!

## 16. Input Connection

### 1. Input logic: without voltage input (NPN)

#### (1). SSR input

Standard sensor: NPN output

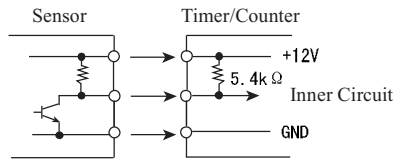

#### (2) Terminal Connection Timer/Counter

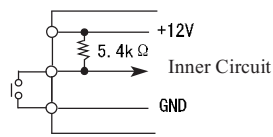

counting speed: 1 or 30cps setting (counter)

### 2. Input logic : voltage input (PNP)

#### (1). SSR input

Standard sensor: NPN output

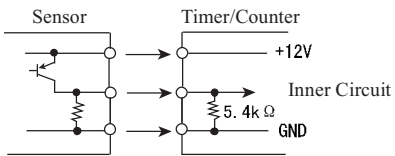

#### (2) Terminal Connection Timer/Counter

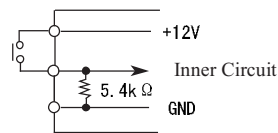

counting speed: 1 or 30cps setting (counter)

## 17. Output Connection

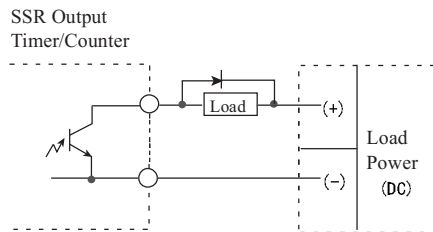
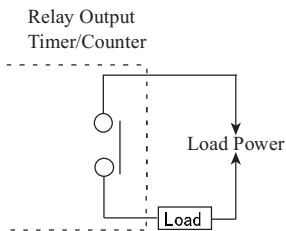

#### SSR Output:

1. Please use adaptable load and power, SSR output can not over then ON/OFF, capacity (30VDC, less than 100mA)
2. Making sure that the power connected in the right way,
3. When using Inductive load(Relay, etc), Filter circuit(Diode, etc) must connect to the load ends

## 18. Dimension

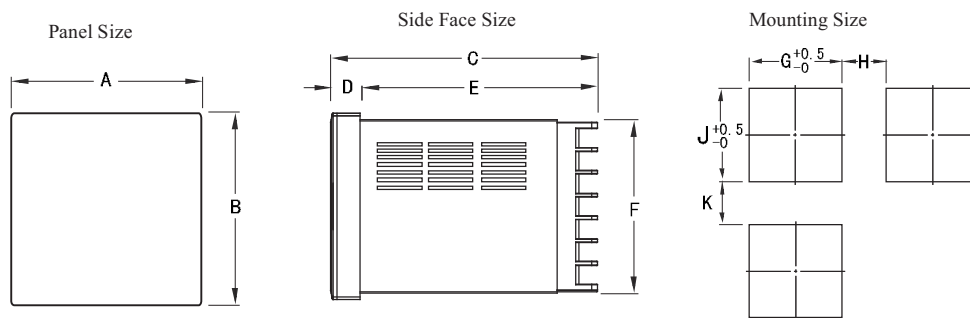

Model	A	B	C	D	E	F	G	H(Min)	J	K(Min)
CI4:(48*48)	48	48	97.5	3	94.5	45	45.5	25	45.5	25
CI7:(72*72)	72	72	97.5	3	94.5	67	67.5	25	67.5	25
CI8:(48*96)	96	48	97.5	3	94.5	44.5	90	25	45	25
CI16:(160*80)	160	80	96	13	83	155	76	30	155.5	30